



Evo Side Mount Control User Manual

2021.04 Version 1.1

Copyright © 2021 ePropulsion. All Rights Reserved

Acknowledgement

Thanks for choosing ePropulsion products, your trust and support in our company are sincerely appreciated. We are dedicated to providing high-performance electric outboards, pod drives, as well as thrusters, reliable lithium batteries and accessories. Welcome to visit www.epropulsion.com and contact us if you have any concerns.

Using This Manual

Before the use of the product, please read this user manual thoroughly to understand the correct and safe operations. By using this product, you hereby agree that you have fully read and understood all contents of this manual. ePropulsion accepts no liability for any damage or injury caused by operations that contradict this manual.

Due to ongoing optimization of our products, ePropulsion reserves the rights of constantly adjusting the contents described in the manual. ePropulsion also reserves the intellectual property rights and industrial property rights including copyrights, patents, logos and designs, etc.

This manual is subject to update without prior notice, please visit our website www.epropulsion.com for the latest version. If you find any discrepancy between your products and this manual, or should you have any doubts concerning the product or the manual, please visit www.epropulsion.com.

ePropulsion reserves the rights of final interpretation of this manual.

This manual is multilingual, in case of any discrepancy in the interpretation of different language versions, the English version shall prevail.

Symbols

The following symbols will help to acquire some key information.

 Important instructions or warnings

 Useful information or tips

Product Identification

Below picture indicates the serial numbers of Evo Side Mount Control and Evo Display Panel. Please note the position of the serial numbers and record them for access to warranty services and other after-sales services. Do not remove or alter the identification label, otherwise the product warranty will be invalid.

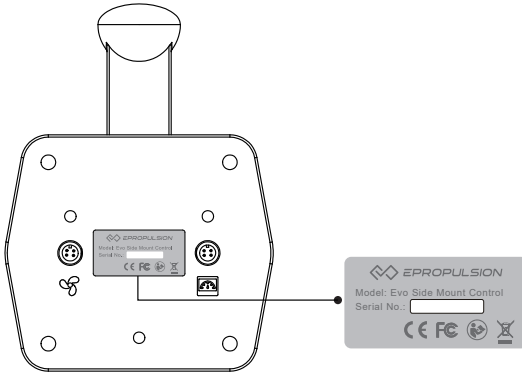

Figure 0-1

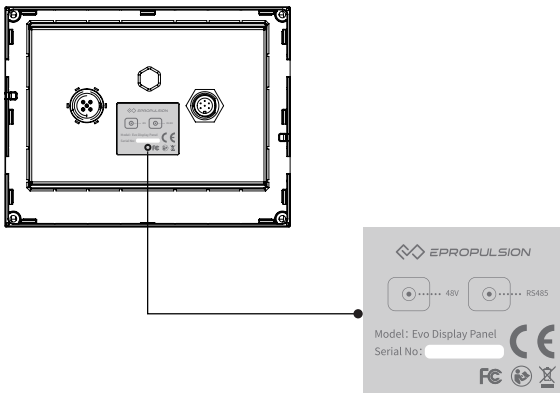

Figure 0-2

Table of Contents

- Acknowledgement..... 1**
- Using This Manual..... 1**
- Symbols 1**
- Product Identification 2**
- Table Content 3**
- 1 Product Overview 5**
 - 1.1 In the Package 5
 - 1.2 Specification 7
 - 1.3 Important Notes 7
 - 1.4 Declaration..... 8
- 2 Mounting 9**
 - 2.1 Mounting the Throttle..... 9
 - 2.1.1 Mounting from the back side 9
 - 2.1.2 Mounting from the front side 10
 - 2.2 Mounting the Display Panel 11
 - 2.3 Connection..... 13
 - 2.4 Version Setting 14
 - 2.5 Port or Starboard Side Setting..... 15
- 3 Features of Components..... 17**
 - 3.1 Detachable Throttle 17
 - 3.1.1 Detach the Handle 17
 - 3.1.2 Install the Handle 17
 - 3.2 Display Panel 18
- 4 Operation Guide..... 21**
 - 4.1 System Settings..... 21
 - 4.1.1 Version Setting..... 21
 - 4.1.2 Power Limited Setting 22
 - 4.1.3 Preference Settings 23
 - 4.1.4 Battery Configuration 24
 - 4.2 Throttle Operation 28

4.2.1 Power Adjusting..... 28

4.2.2 Recalibration 29

4.3 Use of Kill Switch..... 31

4.4 Checklist before Use 32

4.5 Starting the Motor 33

4.6 Stopping the Motor..... 34

5 Warning Messages 35

6 Warranty 41

6.1 Warranty Policies..... 41

6.2 Out of Warranty..... 42



6.3 Warranty Claim Procedures 42

1 Product Overview

Evo Side Mount Control is a wired throttle control handle with a display panel. It is compatible with ePropulsion outboards and pod drives.

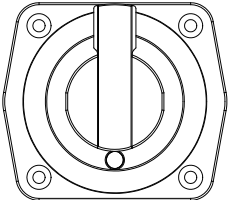
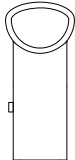
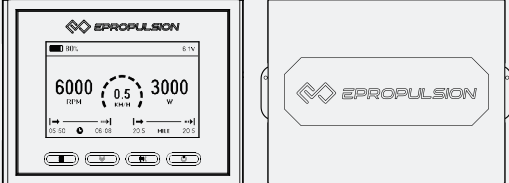

1.1 In the Package

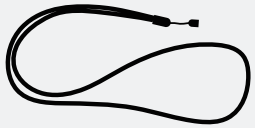
When you receive a set of Evo Side Mount Control, unpack its package and check if all the items below are included in the package. If there is any loss or transport damage, please contact your dealer immediately.

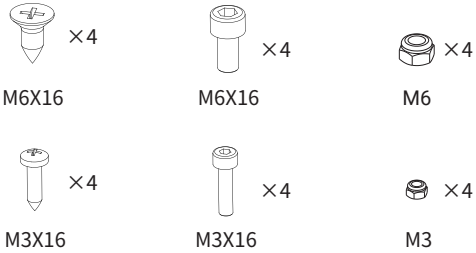
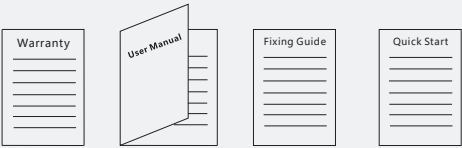
Item	Qty./Unit	Figure
Throttle	1 Set	 
Evo Display Panel (w/ protection cover)	1 Set	
Communication Cable 0.5m	1 Set	 <p style="text-align: center;">0.5m</p>
Kill Switch	2 Sets	

Item	Qty./Unit	Figure
Screws and Nuts	1 Set	 <p>M6X16 M6X16 M6</p> <p>M3X16 M3X16 M3</p>
User Manual, Warranty Card, Quick Start & Fixing Guide	1 Set	 <p>Warranty User Manual Fixing Guide Quick Start</p>

 Save ePropulsion original package for transport and storage.

 Be attention to distinguish the communication ports in the Evo Side Mount Control. Please using a communication cable to connect the motor or the battery to the connector with the sign "  " and use another communication cable to connect the display panel to the connector with the sign "  ".

1.2 Specification

Evo Side Mount Control	
Weight	0.9 kg
Display	4.3" Independent Display
Communication	Wired
Communication Distance	≤ 15 m
Dimensions	117 x 160.3 x 53.6 mm (Throttle) 138.5 x 106.9 x 42.5 mm (Display)

1.3 Important Notes

1. Check the status of the Evo Side Mount Control and battery level before each trip.
2. Only adults who have fully read and understood this manual are allowed to operate this product.
3. Make sure the Evo Side Mount Control is properly installed before use.
4. Be familiar with the basic operation of this product before use, including start-up, stop, control mode, and emergency stop.
5. Make sure that the function of this product is normal before each use.
6. Stop the motor immediately if someone falls overboard during the trip.
7. When using NAVY outboards/Pod Drive 3.0 Evo/Pod Drive 6.0 Evo, the distance and speed value displayed is measured by Global Positioning System (GPS), there may exist small errors due to GPS signal strength degradation or some external environment conditions like currents, winds and change of course.

1.4 Declaration

Object of the declaration:

Product Description: Evo Side Mount Control

Model: Evo Side Mount Control

Company Name: Guangdong ePropulsion Technology Limited

Company Address: Room 201, Bldg.17A, 4th XinZhu Road, SongShan Lake District, Dongguan City, Guangdong Province, China

The object of the declaration is in conformity with the following **directives:**

EMC-directive 2014/30/EU

Applied **standards:**

EN 55014-1:2017

EN 55014-2:2015

EN 61000-3-2:2014

EN 61000-3-3:2013

This device complies with **part 15 of the FCC Rules:** Operation is subject to the following two conditions:

- (1) This device may not cause harmful interference and,
- (2) This device must accept any interference received, including interference that may cause undesired operation.

Signature: 

Shizheng Tao, Chief Executive Officer & Cofounder of Guangdong ePropulsion Technology Limited

2 Mounting

First mount the Evo Side Mount Control including the throttle and the display panel, then connect to the motor and the battery with communication cables, and configure the version and the handle side.

 Before mounting the Evo Side Mount Control, it is recommended to connect the entire equipment first, check whether it works well, and whether the communication cable is properly connected. For the connection method of the communication cable, please refer to 2.3 Connection.

 Make sure the proposed location reserves enough room for operating and will allow rotating the throttle without hitting obstructions.

 When selecting the mounting location, examine your boat to ensure that you will not drill into any obstructions and the throttle will be accessible for assembly, the cables will be accessible for connection.

2.1 Mounting the Throttle

Follow the instructions below to fix the throttle of the Evo Side Mount Control to the boat. It can be mounted from the back side or front side.

2.1.1 Mounting from the back side

1. Drill holes on the hull through the fixing guide referring to the figure 2-1.

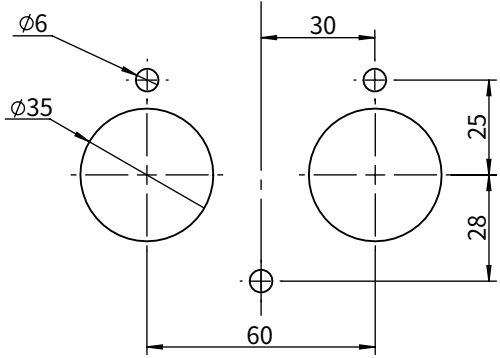

Figure 2-1

2. Fix the throttle to the side of the boat referring to the figure 2-2.

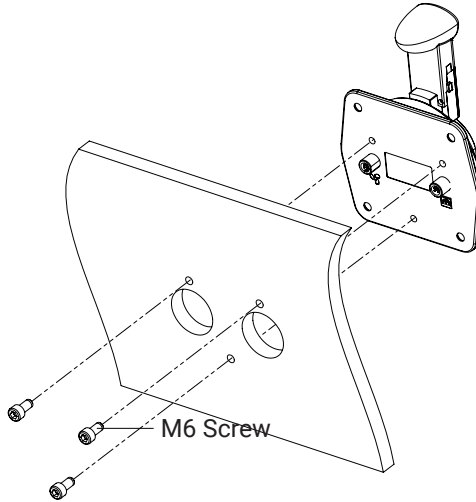

Figure 2-2



If a panel board thickness is between 2mm (0.08 in.) and 8mm (0.31 in.), please use the supplied screws. If not, please purchase suitable screws separately.

2.1.2 Mounting from the front side

1. Drill holes on the hull through the fixing guide referring to the figure 2-3.

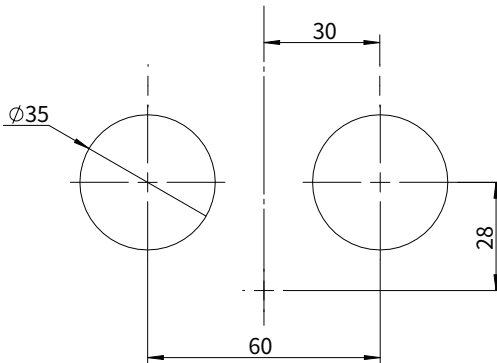

Figure 2-3

2. Fix the throttle to the side of the boat referring to the figure 2-4.

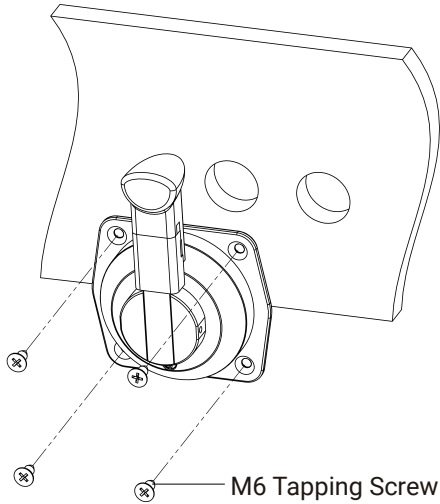



Figure 2-4

 If a panel board thickness is between 2mm (0.08 in.) and 8mm (0.31 in.), please use the supplied screws. If not, please purchase suitable screws separately.

2.2 Mounting the Display Panel

Follow the instructions below to fix the display panel of the Evo Side Mount Control to the boat. It can be mounted from the back side or front side.

1. Drill holes on the hull through the fixing guide referring to the figure 2-5.

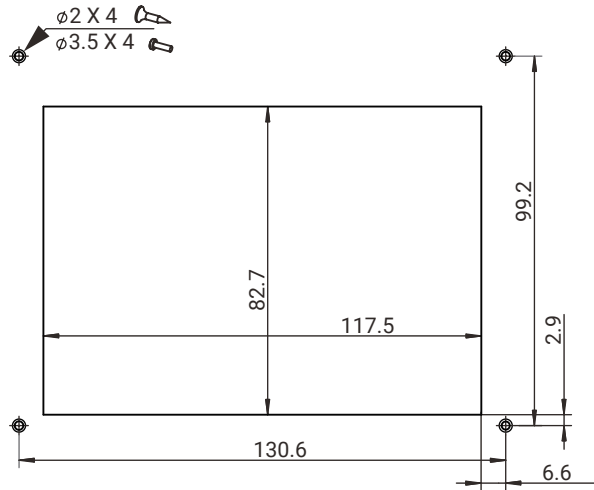

Figure 2-5

2. Remove the trim.
3. Fix the display panel to the boat referring to the figure 2-6.

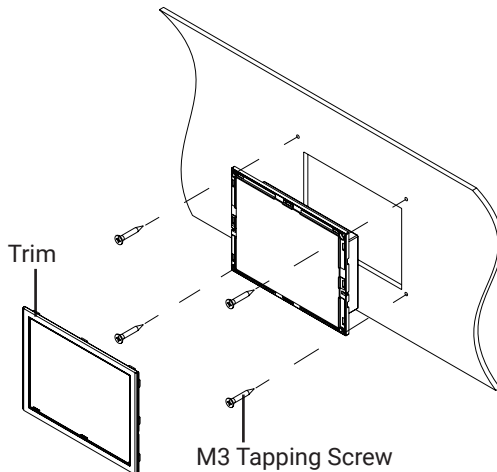

Figure 2-6



If a panel board thickness is between 2mm (0.08 in.) and 8mm (0.31 in.), please use the supplied screws. If not, please purchase suitable screws separately.

2.3 Connection

The Evo Side Mount Control communicates with the motor via communication cables. Please follow the steps below to complete the connection:

1. Connect the throttle and display panel with a communication cable;
2. Connect the motor to the battery.

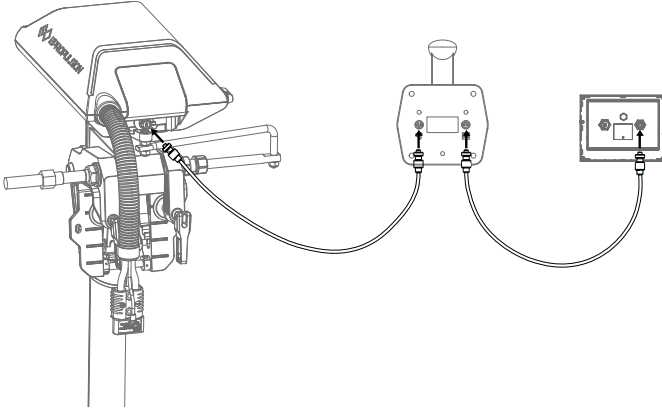

Figure 2-7



Please using a communication cable to connect the motor or the battery to the connector with the sign "⚡" on the Evo Side Mount Control and use another communication cable to connect the display panel to the other connector with the sign "📺".

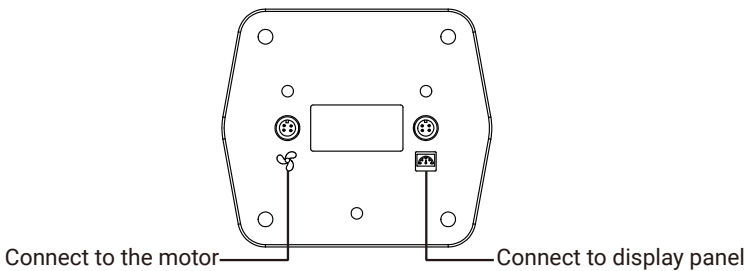

Figure 2-8



If the display panel displays "Equipment offline", please check whether the kill switch is on the proper position. If the kill switch is attached properly, please refer page 33 to solve the problems.

2.4 Version Setting

Evo Side Mount Control will automatically be recognized as an Evo version if it is connected with the Evo machine. If connected with other ePropulsion machine, it is Spirit1.0 version by default. If you need to connect to NAVY outboard or Pod Drive, please switch to a different version according to the following steps:

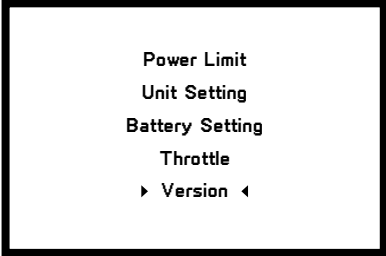
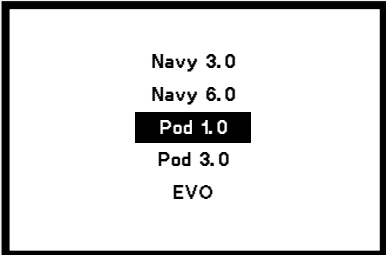
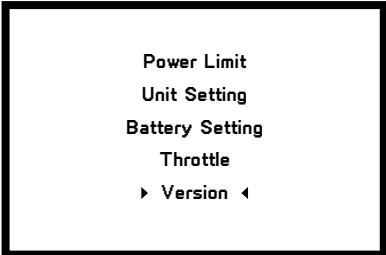
Version Setting Process	LCD Displaying
<p>Step1: In power-on state, long press the Menu button to enter the preference setting page. Press the Select button to switch to "Version" to enter the version setting page.</p>	 <p style="text-align: center;"> Power Limit Unit Setting Battery Setting Throttle ▶ Version ◀ </p>
<p>Step2: Press the Select button to select the version.</p>	 <p style="text-align: center;"> Navy 3.0 Navy 6.0 Pod 1.0 Pod 3.0 EVO </p>
<p>Step3: Press the Confirm button to save the setting. And it will return to preference setting page automatically.</p>	 <p style="text-align: center;"> Power Limit Unit Setting Battery Setting Throttle ▶ Version ◀ </p>

2.5 Port or Starboard Side Setting

Make sure the handle side setting is done correctly before use. The Evo Side Mount Control is in starboard (right) side mode by default. If you need to switch between the port (left) or starboard (right) side, please refer to the following process for setting.

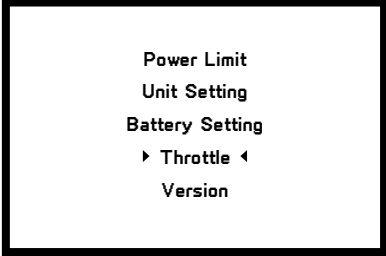
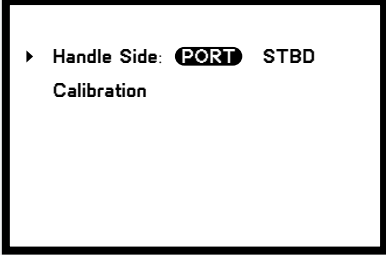
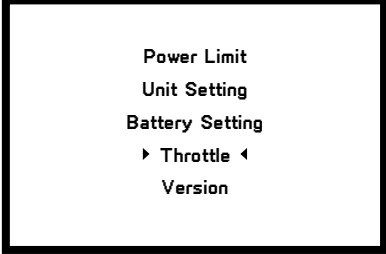
Handle Side Setting Process	LCD Displaying
<p>Step1: In power-on state, long press the Menu button to enter the preference setting page. Press the Select button to switch to "Throttle" and press the Confirm button to enter the Throttle setting page.</p>	 <p style="text-align: center;"> Power Limit Unit Setting Battery Setting ▶ Throttle ◀ Version </p>
<p>Step2: Press the Confirm button to enter the Handle Side setting, then press the Select button to select the port side or the starboard side. Press Confirm button to save the setting.</p>	 <p style="text-align: center;"> ▶ Handle Side: PORT STBD Calibration </p>
<p>Step3: Press Menu button to return to preference setting page automatically.</p>	 <p style="text-align: center;"> Power Limit Unit Setting Battery Setting ▶ Throttle ◀ Version </p>

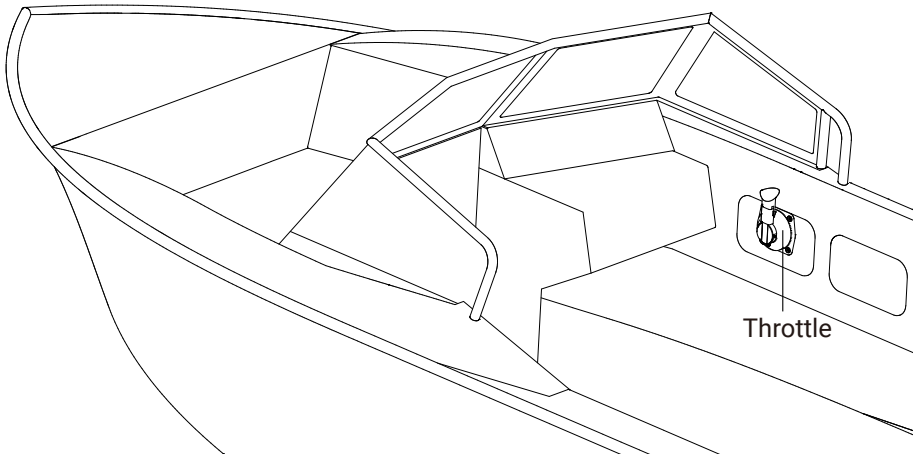

Figure 2-9 Starboard (right) Side

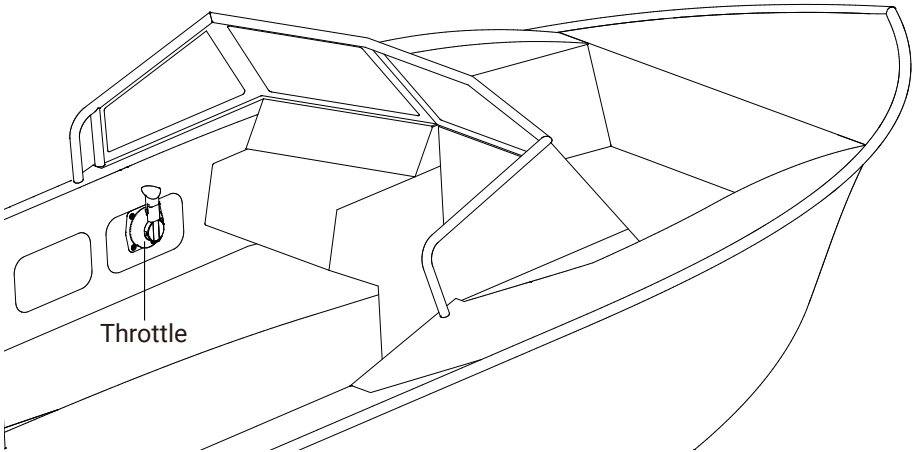

Figure 2-10 Port (left) Side

3 Features of Components

The Evo Side Mount Control is connected to the motor by wire, and used for starting and stopping the motor, adjusting the motor speed, configuring the battery parameters, displaying the system information and messages, etc.

3.1 Detachable Throttle

3.1.1 Detach the Handle

In the original package, the handle of the throttle is an assembly, and it's detachable to change the length of the handle for easier use. If you need to detach the handle of the throttle, please press and hold the release button on the handle and then pull the handle up and out. Refer to the figure below.

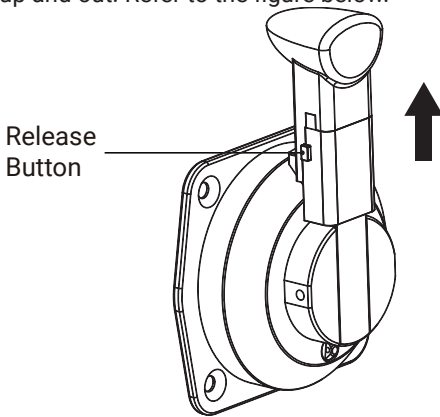

Figure 3-1

3.1.2 Install the Handle

If you need to install the handle to the throttle, please push the handle in the slot to the end then the release button on the handle is stuck.

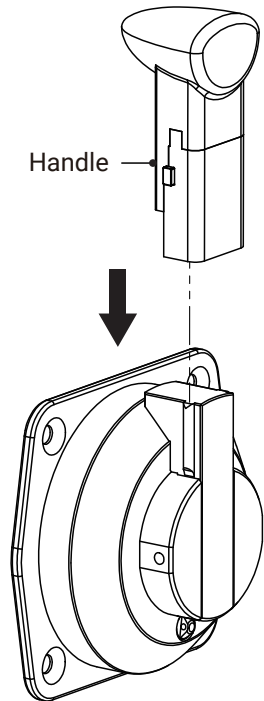
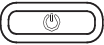







Figure 3-2





3.2 Display Panel







	Buttons	Functions
	Power button	<ol style="list-style-type: none"> 1. When the display panel is turned off, press and hold the power button to power on the display panel. 2. When the display panel is turned on, press and hold the power button to power off the display panel. 3. When the display panel is turned on, press the power button to switch on or off the backlight.
	Confirm button	<ol style="list-style-type: none"> 1. On the main page, press the Confirm button to switch the display between battery level or battery voltage. 2. On setting pages, press the Confirm button to save the current settings and when setting the parameters, press Confirm button to switch to the next item.
	Select button	<ol style="list-style-type: none"> 1. If connecting with NAVY outboards or Pod Drive 3.0/6.0, on the main page, press Select button to change the unit of speed and distance. 2. On setting pages, press Select button to view options for current setting, or adjust configuration parameters.
	Menu	<ol style="list-style-type: none"> 1. In power-on state, long press the Menu button to enter the preference setting page. 2. On setting pages, press Menu button to return to the home page or previous page.

 Please attached the kill switch properly before turning on the display panel, otherwise the display panel will display "Equipment offline".

 All operations on the display panel need to be done in power-on state.

 If users enter the page without setting any parameters, the current parameters displayed on the page will be saved as user parameters by default.

Icons		Functions
	Battery level indicator	Indicating battery level.
48.0V 100%	Battery voltage / level	48.0V : indicates current battery voltage. 100% : indicates current battery level.
	Hydrogeneration indicator	The machine can turn on or off the hydro generation function on the preference page if it supported this function. Shown constantly: the hydro generation function is turned on. Blink: the machine is charging the battery. Hidden: the hydro generation function is turned off.
	GPS status indicator	Hidden: no satellite signal is received or GPS does not work. Blink: GPS is connecting to satellites. Shown constantly: GPS is in use. If connect with SPIRIT 1.0 or Pod Drive 1.0, GPS status indicator will be always hidden.
	Motor over-heat alert	Hidden: system temperature is in normal range. Blink: system temperature is a little high and the maximum input power of motor has been lowered than rated maximum power. Shown constantly: system is over temperature and the outboard will stop working. The outboard motor can't be started until the system temperature drops to a certain level.
	Controller over-heat alert	Hidden: system temperature is in normal range. Blink: system temperature is a little high and the maximum input power of motor has been lowered than rated maximum power. Shown constantly: system is over temperature and the outboard will stop working. The outboard motor can't be started until the system temperature drops to a certain level.

Icons	Functions	
	Fan fault	Hidden: fan works normally. Blink: fan has faults.
RESET	Throttle reset indicator	A blinking "RESET" indicating the throttle should be reset to the neutral position.
3000 W	Throttle Power	Displaying real time input power to the system.
	Current speed	Displaying real time cruising speed. Set units (KM/H, MPH or KNOTS) in preference setting page. If it is connected with SPIRIT outboards or pod drive 1.0, it will display the ePropulsion logo.
6000 RPM	Rotational speed	Displaying real time motor rotational speed.
FNR	Throttle gear	F : forward gear N : neutral gear R : backward gear
	Kill switch status indicator	Hidden: kill switch is well attached and works well. Shown constantly: the kill switch is detached.
	Travelled distance/time or remaining distance/time	 : Remaining distance or time that outboard can travel.  : Travelled distance or time.
	Time display	Displaying real time travel time.
MILE	Distance display	Displaying remaining distance that outboard can travel or travelled distance Set units (MILE, KM (kilometer) and NM (nautical mile)) in preference setting page.

4 Operation Guide

4.1 System Settings

4.1.1 Version Setting

Evo Side Mount Control will automatically be recognized as an Evo version if it is connected with the Evo machine. If connected with other ePropulsion machine, it is Spirit1.0 version by default. If you need to connect to NAVY outboard or Pod Drive, please switch to a different version according to the following steps:

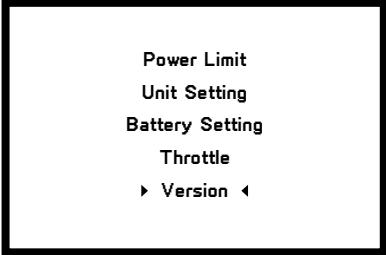
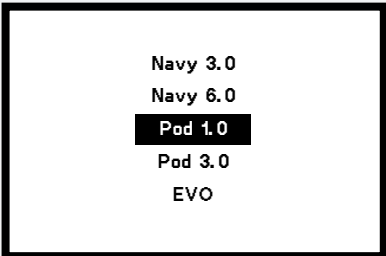
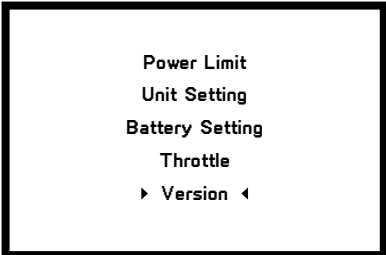
Version Setting Process	LCD Displaying
<p>Step1: In power-on state, press the Menu button and hold for 3s to enter the preference setting page. Press the Select button to switch to "Version". Press the Confirm button to enter Version Setting page.</p>	 <p>Power Limit Unit Setting Battery Setting Throttle ▶ Version ◀</p>
<p>Step2: Press the Select button to choose the version you need.</p>	 <p>Navy 3.0 Navy 6.0 Pod 1.0 Pod 3.0 EVO</p>
<p>Step3: Press the Confirm button to save the setting. And it will return to preference setting page automatically.</p>	 <p>Power Limit Unit Setting Battery Setting Throttle ▶ Version ◀</p>

4.1.2 Power Limited Setting

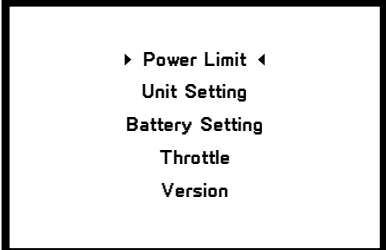
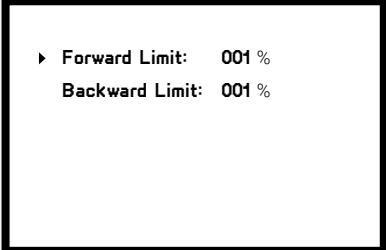
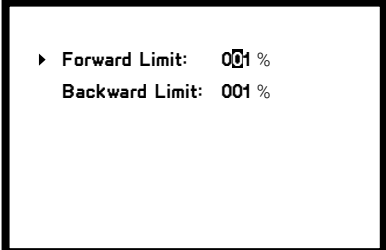
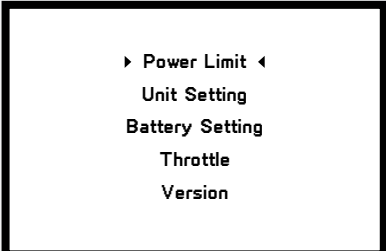
Power Limited Setting Process	LCD Displaying
<p>Step1: In power-on state, long press the Menu button to enter the preference setting page. When the arrow points to "PowerLimit", press the Confirm button to enter the power limit setting page.</p>	 <p>▶ Power Limit ◀ Unit Setting Battery Setting Throttle Version</p>
<p>Step2: Use the Select button to select the power you want to set. "Forward" is the forward power and "Backward" is the backward power. Press the Confirm button to enter this power limit option.</p>	 <p>▶ Forward Limit: 001 % Backward Limit: 001 %</p>
<p>Step3: Please set the three-digit value from left to right through the Select button. Each time you set a value, press the Confirm button to move to the next digit. The flashing value is the value being edited.</p> <p>The power is limited to 1%-100%. The backward power of NAVY 6.0 is limited to 1%-50%.</p>	 <p>▶ Forward Limit: 001 % Backward Limit: 001 %</p>
<p>Step 4: After setting all the values of the forward power limit, press the menu button to return, and press the select button to select the backward power limit option. After the forward and backward power limits are set, press the Menu button to return to the preference setting page, and the setting parameters are automatically saved.</p>	 <p>▶ Power Limit ◀ Unit Setting Battery Setting Throttle Version</p>

4.1.3 Preference Settings

The following speed unit settings and mileage unit settings need to be valid when connected to NAVY machines and pod drive 3.0 or 6.0. Please make sure that the Evo side throttle lever is at Evo, Navy3.0, Navy6.0 or Pod3.0 before setting. It is recommended to follow the steps below to set the display preferences before using the Evo Side Mount Control.

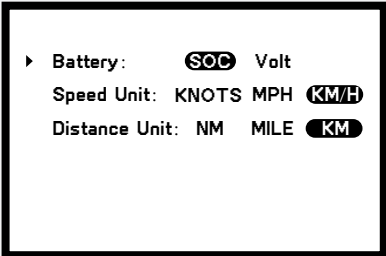
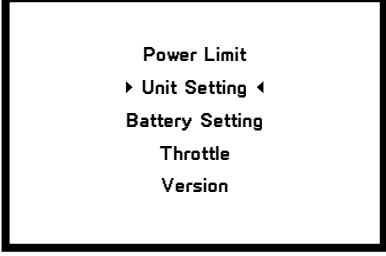
Preference Settings Process	LCD Displaying
<p>Step1: In power-on state, long press the Menu button to enter the preference setting page. Press the Select button to switch to "UnitSetting". Press the Confirm button to enter the unit setting page.</p>	 <p style="text-align: center;"> Power Limit ▶ Unit Setting ◀ Battery Setting Throttle Version </p>
<p>Step2: Press the Confirm button to enter one of the unit setting pages. Press the Select button to choose the unit you want to display.</p> <p>"Battery" is the battery power and voltage display selection. "Distance Unit" is the choice of distance unit; "Speed Unit" is the choice of speed unit.</p> <p>Through the Select button, select the unit to be displayed, and press the Confirm button to confirm. White text on a black background is selected. Press the Menu button to return to previous setting page.</p>	 <p style="text-align: center;"> ▶ Battery: SOC Volt Speed Unit: KNOTS MPH KM/H Distance Unit: NM MILE KM </p>
<p>Step3: Press the Menu button to return to preference setting page.</p>	 <p style="text-align: center;"> Power Limit ▶ Unit Setting ◀ Battery Setting Throttle Version </p>

4.1.4 Battery Configuration

Accurate battery configuration helps achieve precise estimation of the battery's discharging state. When using an ePropulsion Battery and all the communication cables are well connected, the battery configuration is self-configured and the hydrogeneration function can be switched on or off. When not using ePropulsion Batteries, users should manually configure the batteries via Evo Side Mount Control at the first time use, so the battery level will display more accurate.

 When using ePropulsion SPIRIT battery, it does not need to configure the battery.

 Battery configuration should be carried out if a battery with different type/capacity/voltage is connected to motor for the first time. There are some calculation errors in battery level display. Please plan the journey, reserve more than 15% of the endurance power to avoid midway power exhaustion, or prepare enough spare batteries.

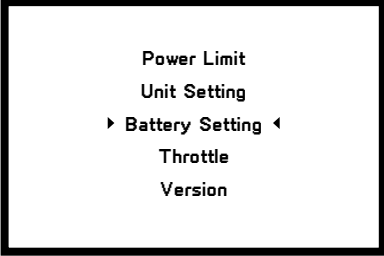
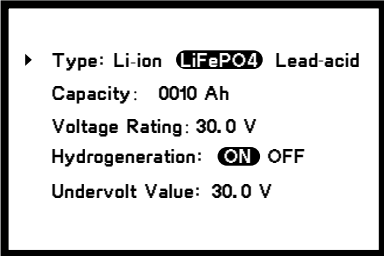
Battery Setting Process	LCD Displaying
<p>Step1: In power-on state, long press the Menu button to enter the preference setting page. Press the Select button to switch to "BatterySetting". Press the Confirm button to enter the battery setting page.</p>	
<p>Step2: When the arrow points to "Type", then press the Confirm button, and choose the battery type according to the battery you use. Press the Select button to switch the battery type options between Li-ion, LiFePO4 and Lead acid.</p> <p>Li-ion: lithium-ion battery LiFePO4: Lithium-ion ferrous phosphate battery Lead acid: Lead-acid battery</p> <p>Press the Confirm button to save the setting for the current item.</p>	

Battery Setting Process	LCD Displaying
<p>Step3: Press the Menu button to return to previous setting page, and press the Select button to switch to "Capacity".</p>	<div style="border: 2px solid black; padding: 10px;"> <p>Type: Li-ion LiFePO4 Lead-acid</p> <p>▶ Capacity: 0010 Ah</p> <p>Voltage Rating: 30.0 V</p> <p>Hydrogeneration: ON OFF</p> <p>Undervolt Value: 30.0 V</p> </div>
<p>Step 4: Press the Confirm button to set the battery capacity setting. Please set the three-digit value through the Select buttons from left to right. After each value is set, press the Confirm button to move to the next value. The flashing value is the value being edited. The battery capacity setting range is 1-9999Ah.</p>	<div style="border: 2px solid black; padding: 10px;"> <p>Type: Li-ion LiFePO4 Lead-acid</p> <p>▶ Capacity: 0010 Ah</p> <p>Voltage Rating: 30.0 V</p> <p>Hydrogeneration: ON OFF</p> <p>Undervolt Value: 30.0 V</p> </div>
<p>Step5: Press the Menu button to return to previous setting page, and press the Select button to switch to "Voltage rating".</p>	<div style="border: 2px solid black; padding: 10px;"> <p>Type: Li-ion LiFePO4 Lead-acid</p> <p>Capacity: 0010 Ah</p> <p>▶ Voltage Rating: 30.0 V</p> <p>Hydrogeneration: ON OFF</p> <p>Undervolt Value: 30.0 V</p> </div>
<p>Step 6: Press the Confirm button to set the rated voltage. Please set the three-digit value through the selection buttons from left to right. After each value is set, press the Confirm button to move to the next value. The flashing value is the value being edited. The battery rated voltage setting range is 30-99.9V.</p>	<div style="border: 2px solid black; padding: 10px;"> <p>Type: Li-ion LiFePO4 Lead-acid</p> <p>Capacity: 0010 Ah</p> <p>▶ Voltage Rating: 30.0 V</p> <p>Hydrogeneration: ON OFF</p> <p>Undervolt Value: 30.0 V</p> </div>

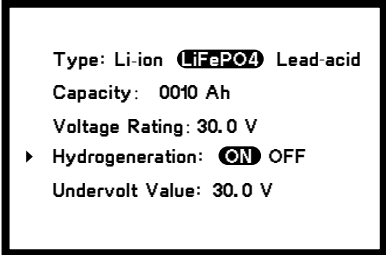
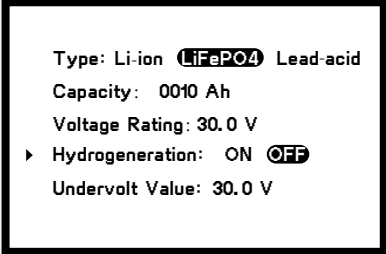
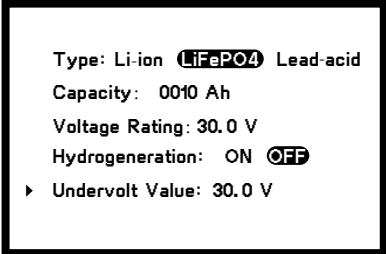
Battery Setting Process	LCD Displaying
<p>Step 7: Press the menu button to return, and press the select button, so that the arrow points to "Hydrogeneration".</p>	 <p>Type: Li-ion LiFePO4 Lead-acid Capacity: 0010 Ah Voltage Rating: 30.0 V ▶ Hydrogeneration: ON OFF Undervolt Value: 30.0 V</p>
<p>Step 8: Press the Confirm button to set the hydro generation function, Press the selection button to switch between "ON, OFF", "ON" to turn on the hydro generation function, models that support the hydro generation function can be turned on, and "OFF" is turn off the hydro generation function.</p> <p>If it is connected to a machine that does not support hydro generation function or the machine is not connected with the battery by a communication cable, the hydro generation function is turned off by default.</p>	 <p>Type: Li-ion LiFePO4 Lead-acid Capacity: 0010 Ah Voltage Rating: 30.0 V ▶ Hydrogeneration: ON OFF Undervolt Value: 30.0 V</p>
<p>Step 9: Press the menu button to return, and press the Select button, so that the arrow points to "Undervolt Value".</p>	 <p>Type: Li-ion LiFePO4 Lead-acid Capacity: 0010 Ah Voltage Rating: 30.0 V Hydrogeneration: ON OFF ▶ Undervolt Value: 30.0 V</p>

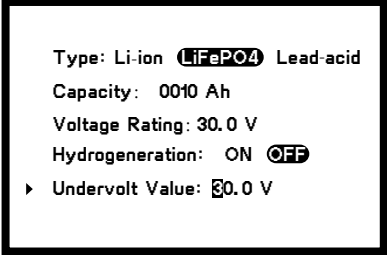
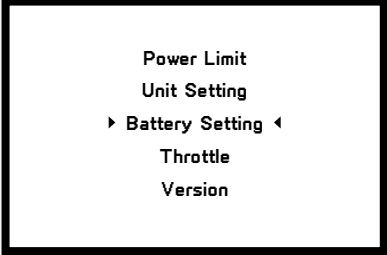
Battery Setting Process	LCD Displaying
<p>Step 10: Press the Confirm button to set the battery undervoltage value. Please set the three-digit value through the selection buttons from left to right. After each value is set, press the Confirm button to move to the next value. The flashing value is the value being edited. The battery undervoltage setting range is 30-99.9V.</p>	 <p>Type: Li-ion LiFePO4 Lead-acid Capacity: 0010 Ah Voltage Rating: 30.0 V Hydrogeneration: ON OFF ▶ Undervolt Value: 30.0 V</p>
<p>Step11: After battery setting is completed, press the Menu button to return to the preference setting page.</p>	 <p>Power Limit Unit Setting ▶ Battery Setting ◀ Throttle Version</p>

 Lithium batteries, lead acid batteries and lithium iron phosphate batteries are recommended to use with NAVY outboard or Pod Drive 3.0/6.0. Other types of battery may fail to make the motor work properly.

 Update the battery configuration is necessary if a different type of battery has been applied.

4.2 Throttle Operation

4.2.1 Power Adjusting

Evo Side Mount Control is used to adjust the input power of the motor. When the battery is properly connected, power on the motor, and then start the Evo Side Mount Control. When the throttle is in the neutral position, first pull the handle away from its base plate along a horizontal direction, then rotate the handle forward or backward to increase the power. Please refer to figure 4-1 and 4-2. When the throttle returns to the neutral position, it will lock automatically. Then need to pull out to continue turning the throttle.

💡 Before power on the Evo Side Mount Control, please reset the throttle to the neutral position. If you find a flickering “RESET” on the display, you are reminded to reset the throttle to the neutral position.

💡 The handle is locked only in the neutral position, there is no need to pull the handle towards outside once it's not in the neutral position.

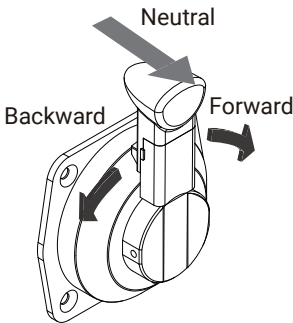

Figure 4-1 Port (left) side mode

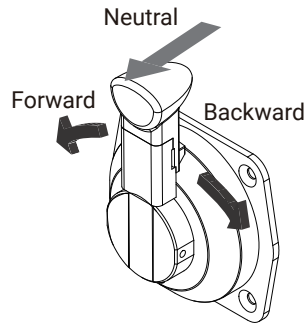

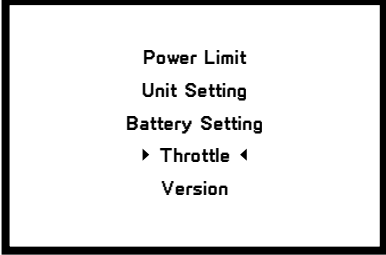
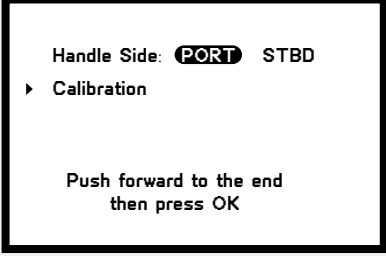
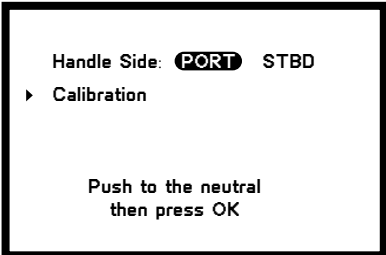
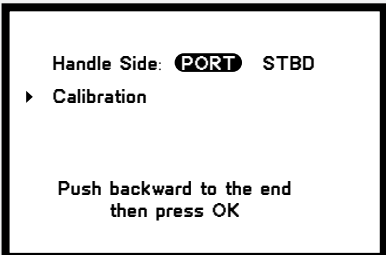

Figure 4-2 Starboard (right) side mode

4.2.2 Recalibration

The throttle position sensor should be recalibrated if the below error code displays.

 Before calibration, if there is no handle side setting, please refer to 2.5 Port and Starboard Side Setting to set the handle side and then carry out the throttle calibration procedures.

Recalibration	LCD Displaying
<p>Step1: In power-on state, long press the Menu button to enter the preference setting page. Press the Select button to switch to the "Throttle". Press the Confirm button to enter throttle setting page.</p>	 <p>Power Limit Unit Setting Battery Setting ▶ Throttle ◀ Version</p>
<p>Step2: Press the Select button to switch to the "Calibration". Press the Confirm button to enter calibration setting page.</p>	 <p>Handle Side: PORT STBD ▶ Calibration</p> <p>Push forward to the end then press OK</p>
<p>Step3: Push the throttle to the maximum forward power position, and then press the Confirm button.</p>	 <p>Handle Side: PORT STBD ▶ Calibration</p> <p>Push to the neutral then press OK</p>
<p>Step4: Pull the throttle to the neutral position, then press the Confirm button.</p>	 <p>Handle Side: PORT STBD ▶ Calibration</p> <p>Push backward to the end then press OK</p>

Recalibration

Step5: Pull the throttle to the maximum backward power position, and then press the Confirm button. Calibration is completed. Then press Confirm button to return to throttle setting page.

LCD Displaying

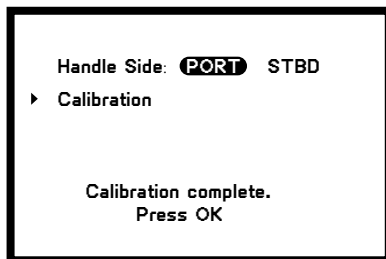

4.3 Use of Kill Switch

Locate the kill switch to the right place on the Evo Side Mount Control and tie its lanyard to your wrist or life jacket. Stop the outboard in emergency by detaching the kill switch.

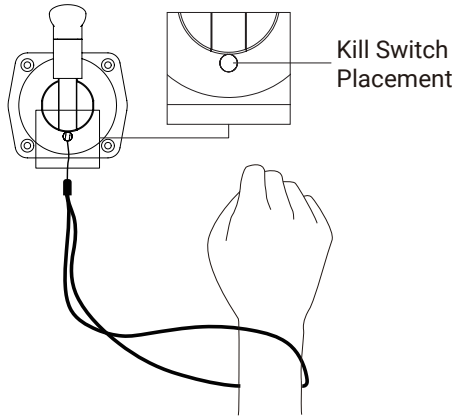





Figure 4-7

-  The kill switch generates magnetic field. Keep it 50cm / 20inches away from medical implants like pacemakers and magnetic cards (e.g. credit card) as well as other magnetic media.
-  The magnetic field of the kill switch may interfere with some electronic instruments. Keep it away from these electronic instruments.

4.4 Checklist before Use

1. Ensure the Evo Side Mount Control and steering wheel are installed in proper position before turning on the power.
2. Ensure the Evo Side Mount Control travels smoothly with no obstructions.
3. Before connecting the battery, check and make sure there is no poor contacts or defects in cables.
4. Before connecting to NAVY outboard or Pod Drive, please check and ensure the main power switch is able to power on and off normally. After that, turn off the main power switch.
5. Ensure the version setting of the Evo Side Mount Control is correspond to the model of the motor.
6. Ensure the battery has enough power.
7. When not using ePropulsion Batteries, ensure the batteries is configured before use.

 Start the motor only when the propeller is beneath water, as the rotating propeller is dangerous.

 If the cable is immersed in water, please dry it completely before connecting it to the battery or power on the system.

4.5 Starting the Motor

1. Complete the check list.
2. Remove the kill switch from the Evo Side Mount Control.
3. Set the throttle in the neutral position.
4. Connect the battery to the motor.
5. If using the outboard, fix the outboard with a proper trim angle.
6. Turn on the main power switch when using the NAVY outboard or Pod Drive. If the outboard is connected to a E series battery, please also press the battery power button to power on.
7. Press Power button to turn on the display panel, then the main page will display.
8. Carry out preference setting and battery configuration if necessary.
9. Tie the kill switch to your wrist or life vest, then attach the kill switch on the Evo Side Mount Control.
10. Pull out the throttle in the neutral position, then push the throttle slowly to start your motor.



If the display panel displays "Equipment offline":

1. Check the kill switch whether attached on the proper position.
2. Please using a communication cable to connect the motor or the battery to the connector with the sign "⚡" on the Evo Side Mount Control and use another communication cable to connect the display panel to the other connector with the sign "🔌".
3. If the connection is correct after double check, there may be the communication fault between the display panel and the throttle. Please check whether the communication cable is loosen or damaged.

4.6 Stopping the Motor

Usually, it's recommended to stop the motor as the following procedures.

1. Return the throttle to the neutral position, then the throttle will lock automatically.
2. Wait until the motor stops, then detach the kill switch from the Evo Side Mount Control.
3. Press and hold the Power button until the Evo Side Mount Control is powered off.
4. If using the NAVY outboard or Pod Drive, turn off the main power switch. If the outboard is connected to a E series battery, please also press the battery power button to power off.
5. If using outboard, tilt the outboard above water surface or detach it from boat.



The motor will stop if one of the situations occurs.

- 1) The throttle is in the neutral position.
- 2) The kill switch is not in the kill switch placement of Evo Side Mount Control.
- 3) The main power switch is off, while using a NAVY outboard or Pod Drive.
- 4) The communication between Evo Side Mount Control and the motor breaks.
- 5) The connection between battery and the motor breaks.
- 6) Failure exists in the control system (e.g. motor is blocked or the low battery voltage level is detected).



In case of emergency, the motor can be stopped by following operations:

- 1) Detach the kill switch.
- 2) Turn the throttle back to the neutral position.

5 Warning Messages



Before conducting warning checks, please check the version of the motor in use. When the motor is running in abnormal conditions or out of order, a warning message with an error code will display on the display panel. Please find more error codes and corresponding solutions in the below table.

a.Warning Messages (Evo Version)

The following error codes and solutions are applicable only to Evo outboard motor and Pod Drive Evo.

Code	Cause	Solution
E01	Battery voltage beyond operation range.	Replace a battery based on suggested operation specifications.
E02	Propeller may be blocked, causing motor overcurrent	Refer to Solution to E10.
	Motor fails or circuit board fails causing motor overcurrent	Try to turn off the main switch and wait for 10 seconds then turn on the switch again.
E06	The battery voltage level is too low.	Operate the motor at low power. Please charge the battery as soon as possible.
E10	Motor stall, which may be caused by blocked propeller	Turn off power, then clean up the things winding around the propeller. Test if the propeller can be rotated by hand before operation.
E11	The temperature of motor is too high.	Stop operating the machine and wait until the temperature falls within the normal operating temperature range.

Code	Cause	Solution
E12	The temperature of circuit board is too high.	Stop operating the machine and wait until the temperature falls within the normal operating temperature range.
E22	MCU Communication Abnormality	Please restart to see if the error disappears, if not, please contact your dealer for help.
E30	Throttle position sensor failure, should recalibrate the throttle position sensor.	Please refer to section 4.2.2 <i>Recalibration</i> to recalibrate the throttle position sensor.
E56	Communication Error between machine and battery	Check if the communication cable between machine and battery is well connected, if yes, please restart the system.
All characters display	The motor has no power.	Connect the battery to the machine and then turn on the main switch.

 If the problem persists, please consult your ePropulsion authorized dealer for assistance.

b.Warning Messages (Spirit1.0 & Pod1.0 Version)

The following error codes and solutions are applicable only to SPIRIT 1.0 outboard motor and Pod Drive 1.0.

Code	Cause	Solution
E01	Motor Over Voltage	Stop the motor and wait until the error message disappears. If the problem still exists, contact your dealer for repairing.
E02	Motor Over Current	Disconnect the battery and check if the motor is blocked. If not, continue driving at low speed. If this issue cannot be solved, please contact your dealer.

Code	Cause	Solution
E03/ E04	Motor Overheating	Wait a few minutes until the motor cools down and the warning message disappears.
E05	Motor Under Voltage	Indicate the battery level is extremely low. The motor can probably be restarted at lower speed after the message is dismissed.
E10	Motor Blocked	Disconnect the battery and remove anything that is blocking the motor. Make sure the propeller can be rotated by hand smoothly.
E20	Battery Communication Fault	Please check whether the version of Evo Side Mount Control corresponds to the motor version first. If not, please refer to <i>2.4 Version Setting</i> for version switching. If the version is correct, turn off the motor and reconnect the battery cable. If this issue cannot be solved, please contact your dealer.
E21	Motor Communication Fault	Turn off the motor and reconnect the battery cable. If this issue cannot be solved please contact your dealer.
E30	Throttle Calibration Required	Please refer to section <i>4.2.2 Recalibration</i> to recalibrate the throttle position sensor.
E51	Battery Charging Temperature Fault	Make sure the environment temperature is within 0°C to 45°C. Charging will continue when cell temperature is in that range.
E54	Battery Discharging Temperature Fault	Detach the battery and contact your dealer.
E55	Battery Pack Over Voltage	Stop the motor and wait until the error message disappears. If the problem persists, contact your dealer for repair.

Code	Cause	Solution
E56	Battery Empty	Indicating the battery is empty. The motor can probably be restarted at lower speed after the message is dismissed.
E57	Battery Charging Over Current	Please contact your dealer.
E58	Battery Discharging Over Current	Please contact your dealer.
E59	Battery Hardware Fault	Battery has encountered serious hardware breakdown. Please replace the battery and contact your dealer.
Other	Battery Cell Fault	Battery cell fault occurs, please replace the battery and contact your dealer to repair the problematic battery.

 If the problem persists, please consult your ePropulsion authorized dealer for assistance.

c.Warning Messages (Navy3.0, Navy6.0 & Pod3.0 Version)

The following error codes and solutions are applicable only to NAVY 3.0, NAVY 6.0 outboard motor and Pod Drive 3.0.

Code	Cause	Solution
E01	Battery voltage is over the operating range.	Replace a battery based on suggested operation specifications.
E02	Propeller may be blocked, causing motor overcurrent	Please refer to the solution to E10.
	Motor fails or circuit board fails causing motor overcurrent	Try to turn off the main power switch and wait for 10 seconds then turn on the switch again.

Code	Cause	Solution
E06	The battery voltage level is too low.	Operate the motor at low power. Please charge the battery as soon as possible.
E10	Motor stall, which may be caused by blocked propeller	Turn off power, then clean up the things winding around the propeller. Test if the propeller can be rotated by hand before operation.
E11	The temperature of motor is too high.	Stop operating the motor and wait until the temperature falls within the normal operating temperature range.
E12	The temperature of circuit board is too high.	Stop operating the motor and wait until the temperature falls within the normal operating temperature range.
E15	Failure was found in the circuit board temperature sensors.	Try to turn off the main power switch and wait for 10 seconds then turn on the switch again.
E16	Calibration Abnormality of Current Sensor	Please contact the dealer for help.
E21	Driver Communication Fault	Please check whether the version of Evo Side Mount Control corresponds to the motor version first. If not, please refer to <i>2.4 Version Setting</i> for version switching. If the version is correct, check the communication cable connection and restart the motor. If the problem still arises, please contact the ePropulsion authorized dealer for assistance.
E22	MCU Communication Abnormality	Please restart to see if the error disappears, if not, please contact your dear for help.

Code	Cause	Solution
E30	Throttle position sensor failure, should recalibrate the throttle position sensor.	Please refer to section 4.2.2 <i>Recalibration</i> to recalibrate the throttle position sensor.
E40	System running failure	Please restart the motor.
E56	Communication Error between NAVY outboard and E series battery	Check if the communication cable between NAVY outboard or Pod Drive 3.0 and E series battery is well connected, if yes, please restart the system.
E57	E series battery overcurrent	<ol style="list-style-type: none"> 1. Ensure the paralleled NAVY batteries have similar voltage with pressure difference within 2V. 2. Ensure the power cable and battery are firmly connected to avoid poor contact. 3. Restart the battery when the error occurs and keep the parallel state for 30 minutes to wait for the batteries to self-balance the voltage. 4. If the error occurs, users can also continue operating after restarting the battery, but do not operate at full power state. The operating power is suggested to be lower than two thirds of full power. Please fully charge the battery after use.

 If the problem persists, please consult your ePropulsion authorized dealer for assistance.





6 Warranty

The ePropulsion limited warranty is provided for the first end purchaser of an ePropulsion product. Consumers are entitled to a free repair or replacement of defective parts or parts which do not conform with the sales contract. This warranty operates in addition to your statutory rights under your local consumer law.

6.1 Warranty Policies

ePropulsion warrants its products to be free of defects in material and workmanship for a limited period since the date of purchase. Once a fault is discovered, the user has the right to make a warranty claim under the ePropulsion warranty policies.

Product	Warranty Expiry Date
Evo Side Mount Control	Two years after the date of purchase.
Components have been repaired or replaced	Three months since the date of maintenance. Note: 1. If the three-month period overlaps with the original warranty period, the warranty against these replaced or repaired parts still expires two years after the date of purchase. 2. If the three-month period exceeds the original warranty period, the repaired or replaced parts continue applying to warranty during the extended period.

-  In order to validate the warranty, users are required to fill in the Warranty Card in the package in advance.
-  Keep the product label in intact state and record the serial number on the label. Never tear the label off the product. An ePropulsion product without the original product label will not be applicable to warranty services provided by ePropulsion.
-  The warranty is valid only when the information is correct and complete.
-  Free warranty is only validated upon the presentation of legal serial number, Warranty Card, and evidence of purchase from an authorized ePropulsion dealer. Valid date of purchase should be established by the first-hand purchaser with original sales slip.

 Free warranty is not transferable and will not be reissued.

 Within the limits of the applicable laws, the warranty policies of ePropulsion may update without prior notice. The latest version is available at our website www.epropulsion.com.

6.2 Out of Warranty

Make sure the product is properly packed during delivery, the original ePropulsion package is recommended. If the product got further damaged due to improper packing during delivery, the furtherly damaged part will be deemed as out of warranty coverage.

In addition, faults or damages caused by the following reasons are also excluded from warranty scope within the covered period:

- Any improper operation contradicts the user manual.
- Accident, misuse, wishful abuse, physical damage, liquid damage, overcharging or unauthorized repair.
- Dropping, improper care or storage.
- Used for commercial purposes.

 You should be noted that minor faults like normal wear and tear that pose no influence on the intended function of the product are also not covered by the warranty.

 Consumables are out of warranty scope.

6.3 Warranty Claim Procedures

If you find your product defective, you can make a claim to your dealer following below procedures:

1. Fill in the Warranty Card correctly and completely in advance. Then make your warranty claim by sending it to your authorized ePropulsion service partner together with valid proof of purchase. Usually these documents are required when making a warranty claim: the Warranty Card, ex-factory serial number, and evidence of purchase.
2. Send the defective product to your authorized ePropulsion service point after getting the confirmation. Note that the label should be kept intact. You can also deliver the product to your authorized ePropulsion dealer after getting confirmation.

3. The defective components or parts will be either repaired or replaced according to the diagnosis made by the ePropulsion authorized service partner.
 4. If your warranty claim is accepted, the equipment will be repaired or replaced free of charge. Note that any delivery cost incurred in the process is at your charge.
 5. After careful examination and confirmation by ePropulsion authorized dealer, the defective or faulty components will be repaired or replaced with brand new ones against the actual condition.
 6. In case your warranty claim be rejected, an estimated repair charge with round trip delivery cost will be sent for confirmation. ePropulsion authorized service point will conduct maintenance accordingly only after your confirmation.
-  If warranty expires, you can still enjoy maintenance services from authorized ePropulsion service partners with minimum maintenance charge.

Thanks for reading this user manual.

If you have any concerns or find any problems while reading, please don't hesitate to contact us. We are delighted to offer service for you.

Guangdong ePropulsion Technology Limited

Website: www.epropulsion.com

Email: service@epropulsion.com