



Evo Dual Remote Control User Manual

2021.04 Version 1.0

Copyright © 2021 ePropulsion All Rights Reserved

Acknowledgement

Thanks for choosing ePropulsion products, your trust and support in our company are sincerely appreciated. We are dedicated to providing high-performance products and accessories.

Welcome to visit www.epropulsion.com and contact us if you have any concerns.

Using This Manual

Before use of the product, please read this user manual thoroughly to understand the correct and safe operations. By using this product, you hereby agree that you have fully read and understood all contents of this manual. ePropulsion accepts no liability for any damage or injury caused by operations that contradict this manual.

Due to ongoing optimization of our products, ePropulsion reserves the rights of constantly adjusting the contents described in the manual. ePropulsion also reserves the intellectual property rights and industrial property rights including copyrights, patents, logos and designs, etc.

This manual is subject to update without prior notice, please visit our website www.epropulsion.com for the latest version. If you find any discrepancy between your products and this manual, or should you have any doubts concerning the product or the manual, please visit www.epropulsion.com.

ePropulsion reserves the rights of final interpretation of this manual.

This manual is multilingual, in case of any discrepancy in the interpretation of different language versions, the English version shall prevail.

Symbols

The following symbols will help to acquire some key information.



Important instructions or warnings



Useful information or tips

Product Identification

Below picture indicates the serial numbers of Evo Dual Remote Control. Please note the position of the serial numbers and record them for access to warranty service and other after-sale services.

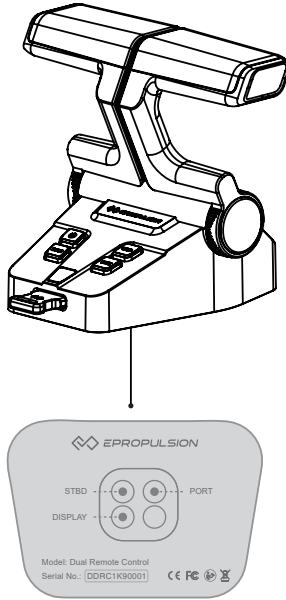

Figure 0-1

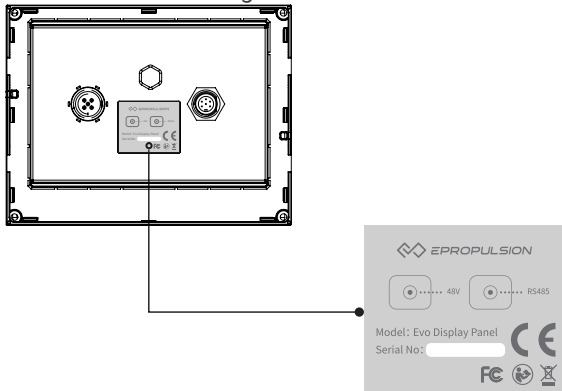

Figure 0-2

Table of content



Acknowledgement	1
Using This Manual	1
Symbols	1
Product Identification	2
1 Product Overview	4
1.1 In the Package	4
1.2 Specification.....	5
1.3 Important Notes	5
1.4 Declaration.....	6
2 Mounting	7
2.1 Mounting the Throttle.....	7
2.2 Connecting the Throttle	7
2.3 Button Description.....	8
2.4 Calibration.....	9
3 Display Panel	11
3.1 Mounting the Display Panel.....	11
3.2 Display Panel	12
3.3 Dock Power Limited Setting	15
3.4 Preference Settings.....	17
3.5 Battery Configuration	19
4 Use of Kill Switch	24
5 Warranty	25
5.1 Warranty Policies.....	25
5.2 Out of Warranty.....	26
5.3 Warranty Claim Procedures	26

1 Product Overview

The Evo Dual Remote Control is used for starting and stopping the outboard motor, adjusting the speed of the motor, configuring the battery parameters, displaying the system information and messages, etc. The Evo Dual Remote Control is powered by connecting to the outboard with a communication cable. When using the Evo Dual Remote Control, it requires an additional steering wheel to help steer.

1.1 In the Package

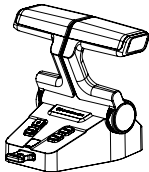
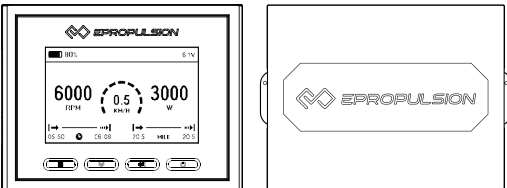
When you receive a set of Evo Dual Remote Control, unpack its package and check if all the items below are included in the package. If there is any loss or transport damage, please contact your dealer immediately.

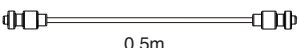
Items	Qty./Unit	Figure
Evo Dual Remote Control (Remote Main Part)	1 set	
Evo Display Panel	1 piece	
User Manual, Warranty Card & Invitation Card	1 set	
Kill Switch	2 pieces	
Communication Cable		

1.2 Specification

Evo Dual Remote Control	
Weight	2.6 kg / 5.7 lbs
Display	4.3" Independent Display
Communication	Wired
Communication Distance	≤ 15 m
Dimensions	151.8 x 178 x 159.4 mm (Remote Main Part) 138.5 x 106.9 x 42.5 mm (Display)

1.3 Important Notes

1. Check the status of the Evo Dual Remote Control and battery level before each trip.
2. Only adults who have fully read and understood this manual are allowed to operate this product.
3. Make sure the Evo Dual Remote Control is properly installed before use.
4. Be familiar with the basic operation of this product before use, including start-up, stop, control mode, and emergency stop.
5. Make sure that the function of this product is normal before each use.
6. Stop the motor immediately if someone falls overboard during the trip.

1.4 Declaration

Object of the declaration:

Product Description: Evo Dual Remote Control

Model: Evo Dual Remote Control

Company Name: Guangdong ePropulsion Technology Limited

Company Address: Room 201, Bldg.17A, 4th XinZhu Road, SongShan Lake District,
Dongguan City, Guangdong Province, China

The object of the declaration is in conformity with the following directives:

EMC-directive 2014/30/EU

Applied standards:

EN 55014-1:2017

EN 55014-2:2015

EN 61000-3-2:2014

EN 61000-3-3:2013

This device complies with part 15 of the FCC Rules: Operation is subject to the following two conditions:

- (1) This device may not cause harmful interference and,
- (2) This device must accept any interference received, including interference that may cause undesired operation.

Signature: 

Shizheng Tao, Chief Executive Officer & Cofounder of

Guangdong ePropulsion Technology Limited

2 Mounting

2.1 Mounting the Throttle

Follow the fixing guide to fix the throttle of the Evo Dual Remote Control to the boat.

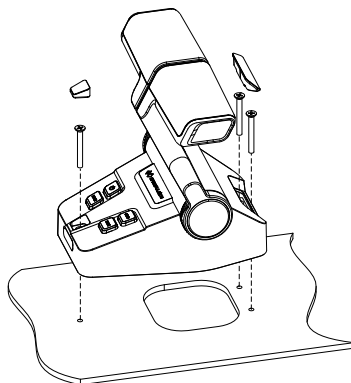

Figure 2-1

2.2 Connecting the Throttle

Please refer the label on the bottom of the Evo Dual Remote Control to connect with the machine and the Evo Display Panel. The starboard side machine should be connected with the STBD connector by a communication cable, and use right side throttle to control it. The port side machine should be connected with the PORT connector by a communication cable. The Evo Display Panel should be connected with the DISPLAY connector.

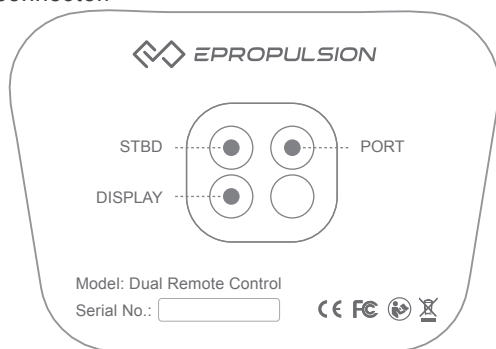

Figure 2-2

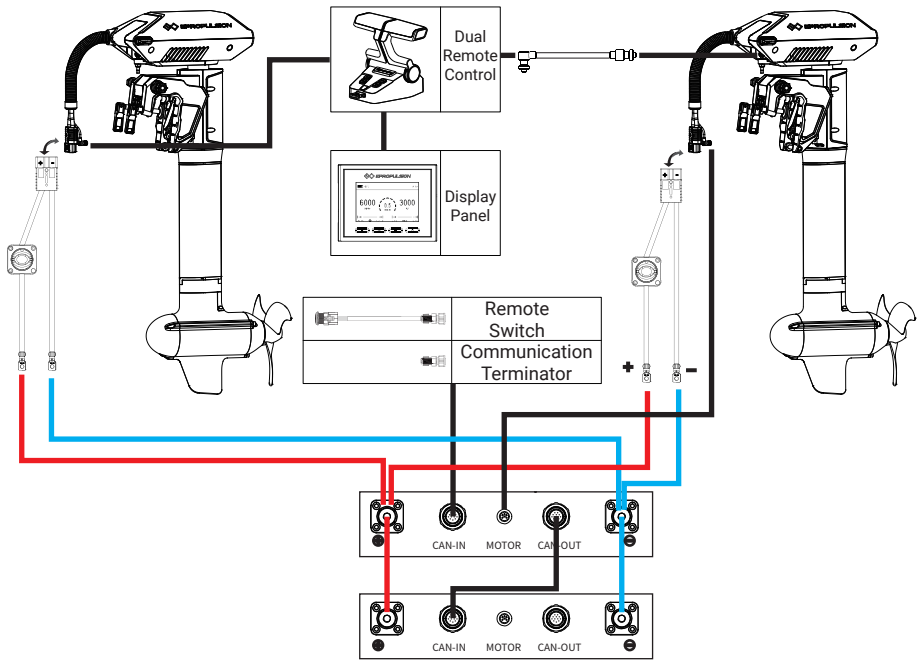



Figure 2-3

2.3 Button Description

Button	Function
 Power button	<ol style="list-style-type: none"> 1. After connecting the dual remote control properly, power on the outboard. Long press the power button, beep means the dual remote control is turned on successfully. 2. When the dual remote control is turned on, long press the power button, beep means the dual remote control is turned off successfully.
NORM Normal mode	<ol style="list-style-type: none"> 1. When the dual remote control is turned on, press the NORM button, beep once means it is switched to normal mode without power limited. 2. When the dual remote control is in the normal mode, long press NORM button for 5 seconds, beep once means it enters the calibration mode.

Button	Function
<p style="text-align: center;">SYNC Synchronization mode</p>	<p>1. When it is turned on, press SYNC button, beep once means it is switched to synchronization mode and the SYNC button light is on.</p> <p>2. When it is in the synchronization mode, long press SYNC button, beep once and the DOCK button light blinks three times. It means that it is switched to the mode that two machines are controlled by right side throttle handle. Then long press SYNC button again, beep once and it is switched to the mode that two machines are controlled by left side throttle handle. These two modes can be switched to each other.</p> <p> When under the synchronization mode, the machines are controlled by right side throttle handle by default.</p>
<p style="text-align: center;">DOCK Dock mode</p>	<p>When it is turned on, press DOCK button, beep once and it is switched to dock mode. The DOCK button light is on and the power is limited to 50%.</p>

2.4 Calibration

Calibration process	Figure
<p>Step 1: When the throttle handle is on the zero position as shown in figure 2-3, long press "NORM" button for 5 seconds to enter calibration mode. Push the throttle handle forward to the maximum position as shown in figure 2-2, and press the "NORM" button to confirm.</p>	<div style="border: 2px solid black; padding: 20px; text-align: center;"> <p>Push forward to the end then press NORM</p> </div>
<p>Step 2: Pull the throttle handle back to the zero position as shown in figure 2-3, and press the "NORM" button to confirm.</p>	<div style="border: 2px solid black; padding: 20px; text-align: center;"> <p>Pull to the neutral then press NORM</p> </div>

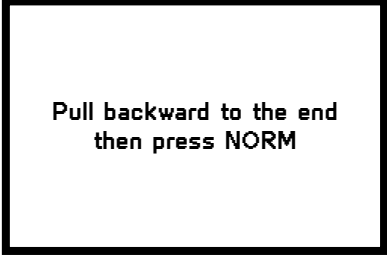
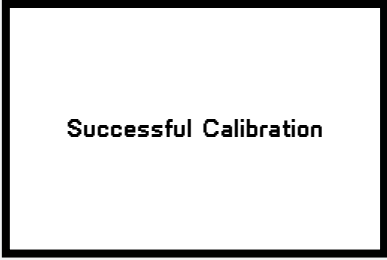
Calibration process	Figure
<p>Step 3: Pull backward the throttle handle to the maximum position as shown in figure 2-4 and press the "NORM" button to confirm.</p>	 <p style="text-align: center;">Pull backward to the end then press NORM</p>
<p>Step 4: Calibration complete.</p>	 <p style="text-align: center;">Successful Calibration</p>

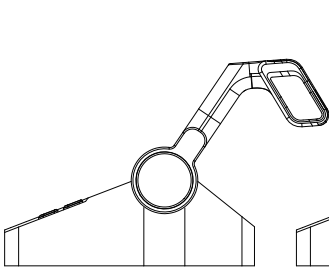

Figure 2-2

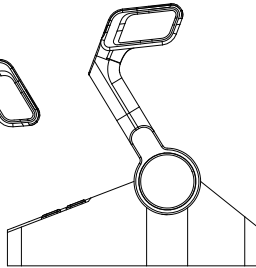

Figure 2-3

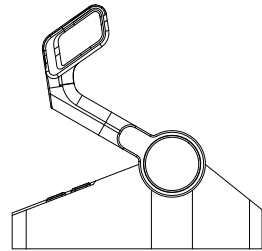

Figure 2-4



If the calibration fails or is not corrected, the NORM button light will blink and the buzzer will sound, and "Calibration failed" will be displayed on the display panel, which needs to be recalibrated. If the calibration is successful, the NORM button light will be on and the buzzer will not sound.

3 Display Panel

3.1 Mounting the Display Panel

Follow the instructions below to fix the display panel of the Evo Dual Remote Control to the boat.

1. Drill holes on the hull through the fixing guide referring to the figure 3-1.

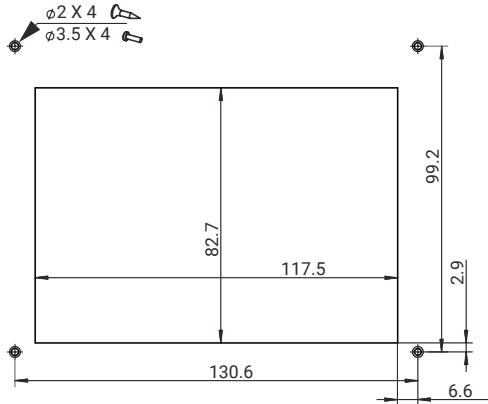

Figure 3-1

2. Remove the trim.
3. Fix the display panel to the boat referring to the figure 3-2.

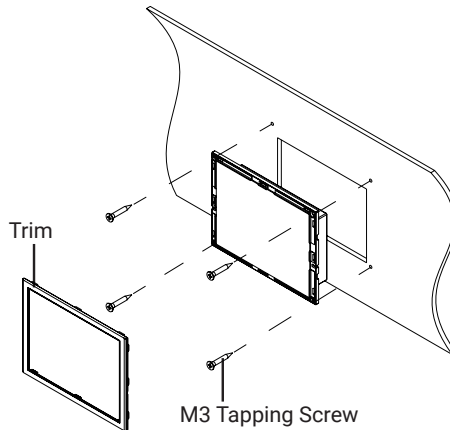
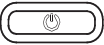





Figure 3-2





If a panel board thickness is between 2mm (0.08 in.) and 8mm (0.31 in.), please use the supplied screws. If not, please purchase suitable screws separately.





3.2 Display Panel







	Buttons	Functions
	Power button	<ol style="list-style-type: none"> 1. When the display panel is turned off, press and hold the power button to power on the display panel. 2. When the display panel is turned on, press and hold the power button to power off the display panel. 3. When the display panel is turned on, press the power button to switch on or off the backlight.
	Confirm button	<ol style="list-style-type: none"> 1. On the main page, press the Confirm button to switch the display between battery level or battery voltage. 2. On setting pages, press the Confirm button to save the current settings and when setting the parameters, press Confirm button to switch to the next item.
	Select button	<ol style="list-style-type: none"> 1. If connecting with NAVY outboards or Pod Drive 3.0/6.0, on the main page, press Select button to change the unit of speed and distance. 2. On setting pages, press Select button to view options for current setting, or adjust configuration parameters.
	Menu	<ol style="list-style-type: none"> 1. In power-on state, long press the Menu button to enter the preference setting page. 2. On setting pages, press Menu button to return to the home page or previous page.

 Please attached the kill switch properly before turning on the display panel, otherwise the display panel will display “Equipment offline”.

 All operations on the display panel need to be done in power-on state.

 If users enter the page without setting any parameters, the current parameters displayed on the page will be saved as user parameters by default.

Icons		Functions
	Battery level indicator	Indicating battery level.
48.0V 100%	Battery voltage / level	48.0V : indicates current battery voltage. 100% : indicates current battery level.
	Hydrogeneration indicator	The machine can turn on or off the hydro generation function on the preference page if it supported this function. Shown constantly: the hydro generation function is turned on. Blink: the machine is charging the battery. Hidden: the hydro generation function is turned off.
	GPS status indicator	Hidden: no satellite signal is received or GPS does not work. Blink: GPS is connecting to satellites. Shown constantly: GPS is in use. If connect with SPIRIT 1.0 or Pod Drive 1.0, GPS status indicator will be always hidden.
	Motor over-heat alert	Hidden: system temperature is in normal range. Blink: system temperature is a little high and the maximum input power of motor has been lowered than rated maximum power. Shown constantly: system is over temperature and the outboard will stop working. The outboard motor can't be started until the system temperature drops to a certain level.
	Controller over-heat alert	Hidden: system temperature is in normal range. Blink: system temperature is a little high and the maximum input power of motor has been lowered than rated maximum power. Shown constantly: system is over temperature and the outboard will stop working. The outboard motor can't be started until the system temperature drops to a certain level.

Icons		Functions
	Fan fault	Hidden: fan works normally. Blink: fan has faults.
RESET	Throttle reset indicator	A blinking "RESET" indicating the throttle should be reset to the neutral position.
3000 W	Throttle power	Displaying real time input power to the system.
	Current speed	Displaying real time cruising speed. Set units (KM/H, MPH or KNOTS) in preference setting page. If it is connected with SPIRIT outboards or pod drive 1.0, it will display the ePropulsion logo.
6000 RPM	Rotational speed	Displaying real time motor rotational speed.
FNR	Throttle gear	F : forward gear N : neutral gear R : backward gear
	Kill switch status indicator	Hidden: kill switch is well attached and works well. Shown constantly: the kill switch is detached.
	Travelled distance/time or remaining distance/time	 : Remaining distance or time that outboard can travel.  : Travelled distance or time.
	Time display	Displaying real time travel time.
MILE	Distance display	Displaying remaining distance that outboard can travel or travelled distance Set units (MILE, KM (kilometer) and NM (nautical mile)) in preference setting page.

3.3 Dock Power Limited Setting

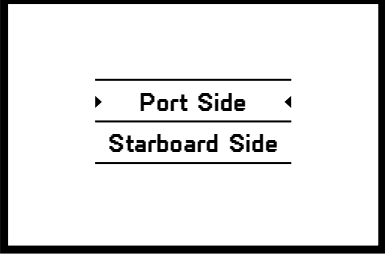
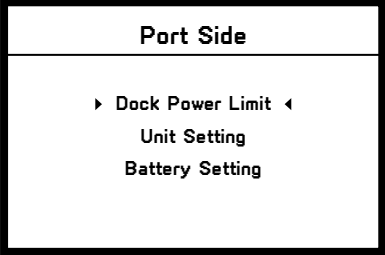
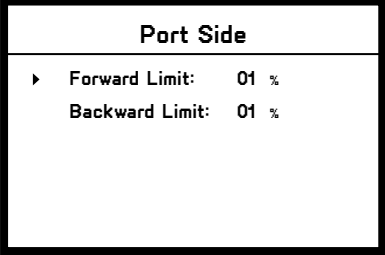
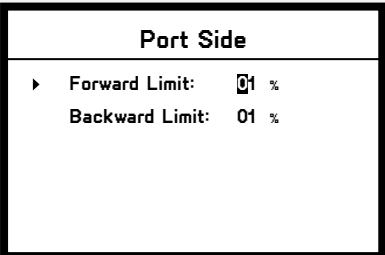
Dock Power Limited Setting Process	LCD Displaying
<p>Step1: In power-on state, long press the Menu button to enter the Port or Starboard Side Setting page, and press Select button the select Port or Starboard Side. Then press Confirm button to enter the Setting page.</p>	 <p>The LCD display shows a menu with two options: "Port Side" and "Starboard Side". Both options are underlined and have left and right arrow symbols next to them, indicating they are selectable.</p>
<p>Step2: Press Select button to switch to Dock Power Limit, then press Confirm button to enter the Dock Power Limit page.</p>	 <p>The LCD display shows a menu with two options: "Dock Power Limit" and "Unit Setting". Both options are underlined and have left and right arrow symbols next to them, indicating they are selectable.</p>
<p>Step3: Use the Select button to select the power you want to set. "Forward" is the forward power and "Backward" is the backward power. Press the Confirm button to enter this power limit option.</p>	 <p>The LCD display shows a menu with two options: "Forward Limit" and "Backward Limit". Both options are underlined and have left and right arrow symbols next to them, indicating they are selectable. The values are set to "01 %".</p>
<p>Step4: Please set the two-digit value from left to right through the Select button. Each time you set a value, press the Confirm button to move to the next digit. The flashing value is the value being edited. The power is limited to 1%-50%.</p>	 <p>The LCD display shows a menu with two options: "Forward Limit" and "Backward Limit". Both options are underlined and have left and right arrow symbols next to them, indicating they are selectable. The values are set to "01 %". The digit "0" in "01" is flashing, indicating it is the current digit being edited.</p>

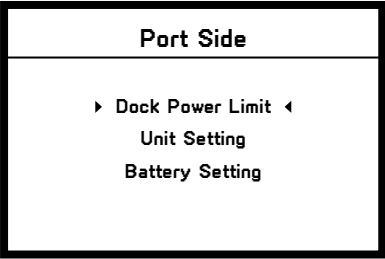
Dock Power Limited Setting Process	LCD Displaying
<p>Step 5: After setting all the values of the forward power limit, press the Menu button to return, and press the select button to select the backward power limit option. After the forward and backward power limits are set, press the Menu button to return to the preference setting page, and the setting parameters are automatically saved.</p>	 The image shows a rectangular LCD display with a black border. At the top, it says "Port Side". Below that, there is a horizontal line. Under the line, the text "Dock Power Limit" is centered, flanked by right and left arrowheads. Below this, "Unit Setting" and "Battery Setting" are listed vertically in the center. <p>Port Side</p> <p>▶ Dock Power Limit ◀</p> <p>Unit Setting</p> <p>Battery Setting</p>

3.4 Preference Settings

It is recommended to refer the steps below to set the displaying preference before operating the dual remote control

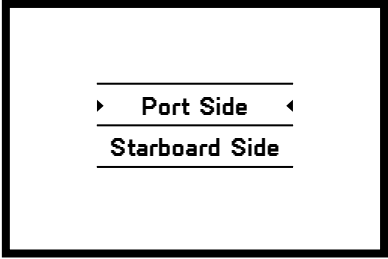
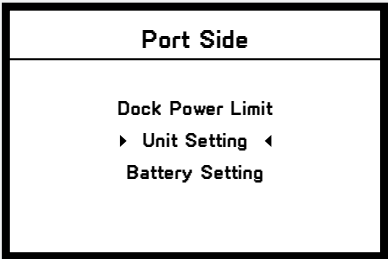
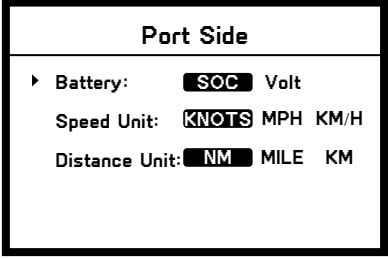
Preference Settings Process	LCD Displaying
<p>Step1: In power-on state, long press the Menu button to enter the Port or Starboard Side Setting page, and press Select button the select Port or Starboard Side. Then press Confirm button to enter the Setting page.</p>	
<p>Step2: Press the Select button to switch to "UnitSetting". Press the Confirm button to enter the unit setting page.</p>	
<p>Step3: Press the Select button to choose the unit you want to display.</p> <p>"Battery" is the battery power and voltage display selection. "Distance Unit" is the choice of distance unit; "Speed Unit" is the choice of speed unit.</p> <p>Through the Select button, select the unit to be displayed, and press the Confirm button to confirm. White text on a black background is selected. Press the Menu button to return to previous setting page.</p>	

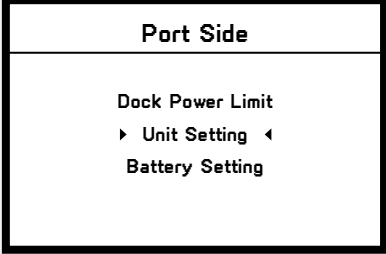
Preference Settings Process	LCD Displaying
<p>Step4: Press the Menu button to return to preference setting page.</p>	 <p>The LCD display shows a menu titled "Port Side". Below the title, there are three options: "Dock Power Limit", "Unit Setting", and "Battery Setting". The "Unit Setting" option is highlighted with a right-pointing arrow (▶) on its left and a left-pointing arrow (◀) on its right.</p>

3.5 Battery Configuration

Accurate battery configuration helps achieve precise estimation of the battery's discharging state. When using an ePropulsion Battery and all the communication cables are well connected, the battery configuration is self-configured and the hydrogeneration function can be switched on or off. When not using ePropulsion Batteries, users should manually configure the batteries via Evo Dual Remote Control at the first time use, so the battery level will display more accurate.



When using ePropulsion SPIRIT battery, it does not need to configure the battery.

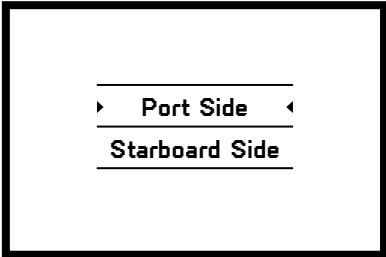
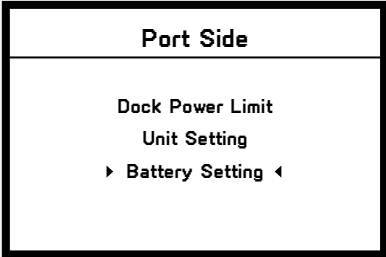

Battery configuration should be carried out if a battery with different type/capacity/voltage is connected to motor for the first time. There are some calculation errors in battery level display. Please plan the journey, reserve more than 15% of the endurance power to avoid midway power exhaustion, or prepare enough spare batteries.

Battery Setting Process	LCD Displaying
<p>Step1: In power-on state, long press the Menu button to enter the Port or Starboard Side Setting page, and press Select button the select Port or Starboard Side. Then press Confirm button to enter the Setting page.</p>	
<p>Step2: Press the Select button to switch to Battery Setting. Press the Confirm button to enter the battery setting page.</p>	

Battery Setting Process	LCD Displaying
<p>Step3: When the arrow points to "Type", then press the Confirm button, and choose the battery type according to the battery you use. Press the Select button to switch the battery type options between Li-ion, LiFePO4 and Lead acid.</p> <p>Li-ion: lithium-ion battery LiFePO4: Lithium-ion ferrous phosphate battery Lead acid: Lead-acid battery</p> <p>Press the Confirm button to save the setting for the current item.</p>	<div data-bbox="564 269 951 525" style="border: 2px solid black; padding: 10px;"> <p style="text-align: center;">Port Side</p> <hr/> <p>▶ Type: Li-ion LiFePO4 Lead-acid Capacity: 0010 Ah Voltage Rating: 30.0 V Hydrogeneration: ON OFF Undervolt Value: 30.0 V</p> </div>
<p>Step4: Press the Menu button to return to previous setting page, and press the Select button to switch to «Capacity».</p>	<div data-bbox="564 700 951 956" style="border: 2px solid black; padding: 10px;"> <p style="text-align: center;">Port Side</p> <hr/> <p>▶ Type: Li-ion LiFePO4 Lead-acid ▶ Capacity: 0010 Ah Voltage Rating: 30.0 V Hydrogeneration: ON OFF Undervolt Value: 30.0 V</p> </div>
<p>Step 5: Press the Confirm button to set the battery capacity setting. Please set the three-digit value through the Select buttons from left to right. After each value is set, press the Confirm button to move to the next value. The flashing value is the value being edited. The battery capacity setting range is 1-9999Ah.</p>	<div data-bbox="564 1035 951 1291" style="border: 2px solid black; padding: 10px;"> <p style="text-align: center;">Port Side</p> <hr/> <p>Type: Li-ion LiFePO4 Lead-acid ▶ Capacity: 0010 Ah Voltage Rating: 30.0 V Hydrogeneration: ON OFF Undervolt Value: 30.0 V</p> </div>

Battery Setting Process	LCD Displaying
<p>Step6: Press the Menu button to return to previous setting page, and press the Select button to switch to «Voltage rating».</p>	<div style="border: 2px solid black; padding: 10px;"> <p style="text-align: center;">Port Side</p> <hr/> <p>Type: Li-ion LiFePO4 Lead-acid Capacity: 0010 Ah ▶ Voltage Rating: 30.0 V Hydrogeneration: ON OFF Undervolt Value: 30.0 V</p> </div>
<p>Step 7: Press the Confirm button to set the rated voltage. Please set the three-digit value through the selection buttons from left to right. After each value is set, press the Confirm button to move to the next value. The flashing value is the value being edited. The battery rated voltage setting range is 30-99.9V.</p>	<div style="border: 2px solid black; padding: 10px;"> <p style="text-align: center;">Port Side</p> <hr/> <p>Type: Li-ion LiFePO4 Lead-acid Capacity: 0010 Ah ▶ Voltage Rating: 30.0 V Hydrogeneration: ON OFF Undervolt Value: 30.0 V</p> </div>
<p>Step 8: Press the menu button to return, and press the select button, so that the arrow points to "Hydrogeneration".</p>	<div style="border: 2px solid black; padding: 10px;"> <p style="text-align: center;">Port Side</p> <hr/> <p>Type: Li-ion LiFePO4 Lead-acid Capacity: 0010 Ah Voltage Rating: 30.0 V ▶ Hydrogeneration: ON OFF Undervolt Value: 30.0 V</p> </div>

Battery Setting Process	LCD Displaying
<p>Step 9: Press the Confirm button to set the hydro generation function, Press the selection button to switch between "ON, OFF", "ON" to turn on the hydro generation function, models that support the hydro generation function can be turned on, and "OFF" is turn off the hydro generation function.</p> <p>If it is connected to a machine that does not support hydro generation function or the machine is not connected with the battery by a communication cable, the hydro generation function is turned off by default.</p>	<div data-bbox="564 276 952 533" style="border: 2px solid black; padding: 10px;"> <p style="text-align: center;">Port Side</p> <hr/> <p>Type: Li-ion LiFePO4 Lead-acid Capacity: 0010 Ah Voltage Rating: 30.0 V ▶ Hydrogeneration: ON OFF Undervolt Value: 30.0 V</p> </div>
<p>Step 10: Press the menu button to return, and press the Select button, so that the arrow points to "Undervolt Value".</p>	<div data-bbox="564 730 952 987" style="border: 2px solid black; padding: 10px;"> <p style="text-align: center;">Port Side</p> <hr/> <p>Type: Li-ion LiFePO4 Lead-acid Capacity: 0010 Ah Voltage Rating: 30.0 V Hydrogeneration: ON OFF ▶ Undervolt Value: 30.0 V</p> </div>
<p>Step 11: Press the Confirm button to set the battery undervoltage value. Please set the three-digit value through the selection buttons from left to right. After each value is set, press the Confirm button to move to the next value. The flashing value is the value being edited. The battery undervoltage setting range is 30-99.9V.</p>	<div data-bbox="564 1066 952 1323" style="border: 2px solid black; padding: 10px;"> <p style="text-align: center;">Port Side</p> <hr/> <p>Type: Li-ion LiFePO4 Lead-acid Capacity: 0010 Ah Voltage Rating: 30.0 V Hydrogeneration: ON OFF ▶ Undervolt Value: 30.0 V</p> </div>

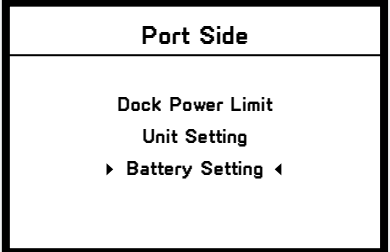
Battery Setting Process	LCD Displaying
<p>Step12: After battery setting is completed, press the Menu button to return to the preference setting page.</p>	 <p>The LCD display shows the 'Port Side' menu with the following options:</p> <ul style="list-style-type: none">Dock Power LimitUnit Setting▶ Battery Setting ◀

 Update the battery configuration is necessary if a different type of battery has been applied.

4 Use of Kill Switch

Locate the kill switch to the right place on the Evo Dual Remote Control and tie its lanyard to your wrist or life jacket. Stop the outboard in emergency by detaching the kill switch.

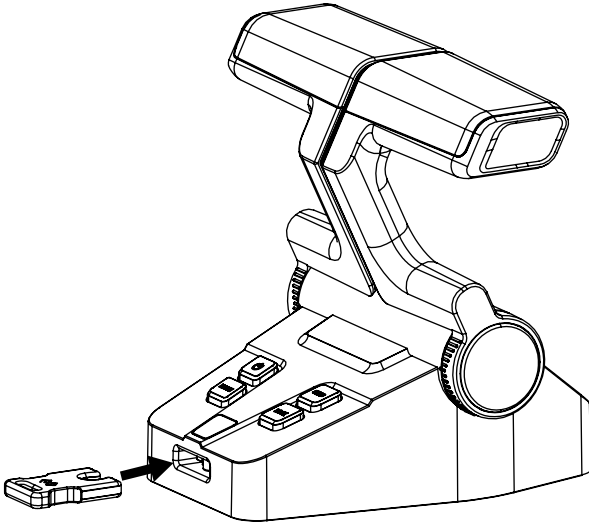



Figure 4-1

-  Please remove the kill switch after the machine is turned off. Failure to remove the kill switch will cause continuous power consumption of the battery (when the battery is connected).
-  After connecting the machine and the battery, please attach the kill switch properly before turning on the machine, otherwise the machine will not work normally.





5 Warranty

The ePropulsion limited warranty is provided for the first end purchaser of an ePropulsion product. Consumers are entitled to a free repair or replacement of defective parts or parts which do not conform with the sales contract. This warranty operates in addition to your statutory rights under your local consumer law.

5.1 Warranty Policies

ePropulsion warrants its products to be free of defects in material and workmanship for a limited period since the date of purchase. Once a fault is discovered, the user has the right to make a warranty claim under the ePropulsion warranty policies.

Product	Warranty Expiry Date
Evo Dual Remote Control	Two years after the date of purchase.
Components have been repaired or replaced	<p>Three months since the date of maintenance.</p> <p>Note:</p> <ol style="list-style-type: none"> 1. If the three-month period overlaps with the original warranty period, the warranty against these replaced or repaired parts still expires two years after the date of purchase. 2. If the three-month period exceeds the original warranty period, the repaired or replaced parts continue applying to warranty during the extended period.

-  In order to validate the warranty, users are required to fill in the Warranty Card in the package in advance.
-  Keep the product label in intact state and record the serial number on the label. Never tear the label off the product. An ePropulsion product without the original product label will not be applicable to warranty services provided by ePropulsion.
-  The warranty is valid only when the information is correct and complete.
-  Free warranty is only validated upon the presentation of legal serial number, Warranty Card, and evidence of purchase from an authorized ePropulsion dealer.
-  Valid date of purchase should be established by the first-hand purchaser with original sales slip.



Free warranty is not transferable and will not be reissued.



Within the limits of the applicable laws, the warranty policies of ePropulsion may update without prior notice. The latest version is available at our website www.epropulsion.com.

5.2 Out of Warranty

Make sure the product is properly packed during delivery, the original ePropulsion package is recommended. If the product got further damaged due to improper packing during delivery, the furtherly damaged part will be deemed as out of warranty coverage.

In addition, faults or damages caused by the following reasons are also excluded from warranty scope within the covered period:

- Any improper operation contradicts the user manual.
- Accident, misuse, wishful abuse, physical damage overcharging, liquid damage or unauthorized repair.
- Dropping, improper care or storage.



You should be noted that minor faults like normal wear and tear that pose no influence on the intended function of the product are also not covered by the warranty.



Consumables are out of warranty scope.

5.3 Warranty Claim Procedures

If you find your product defective, you can make a claim to your dealer following below procedures:

1. Fill in the Warranty Card correctly and completely in advance. Then make your warranty claim by sending it to your authorized ePropulsion service partner together with valid proof of purchase. Usually these documents are required when making a warranty claim: the Warranty Card, ex-factory serial number, and evidence of purchase.
2. Send the defective product to your authorized ePropulsion service point after getting the confirmation. Note that the label should be kept intact. You can also deliver the product to your authorized ePropulsion dealer after getting confirmation.

1. The defective components or parts will be either repaired or replaced according to the diagnosis made by the ePropulsion authorized service partner.
2. If your warranty claim is accepted, the equipment will be repaired or replaced free of cost. Note that any delivery cost incurred in the process is at your charge.
3. After careful examination and confirmation by ePropulsion authorized dealer, the defective or faulty components will be repaired or replaced with brand new ones against the actual condition.
4. In case your warranty claim is rejected, an estimated repair charge with round trip delivery cost will be sent for confirmation. ePropulsion authorized service point will conduct maintenance accordingly only after your confirmation.



If warranty expires, you can still enjoy maintenance services from authorized ePropulsion service partners with minimum maintenance charge.

Thanks for reading this user manual.

If you have any concerns or find any problems while reading, please don't hesitate to contact us. We are delighted to offer service for you.

Guangdong ePropulsion Technology Limited

Website: www.epropulsion.com

Email: service@epropulsion.com